

Elegant Touch To Entry



high quality door handles



DH-20011	HA4	PH-4919-EHB001	HA9
DH-20021	HA4	PH-4920-EHB001	HA9
DH-20031	HA4	PH-4922-EHB002	HA9
DH-20041	HA4	PH-4924-EHB006	HA9
DH-20051	HA4	PHS-4926-EHB005	HA10
DH-20061	HA4	PHS-4930-EHB004	HA10
DH-20211	HA5	PHS-4960-EHB021	HA11
DH-20221	HA5	PK-4931-SBK801	HA10
EHB001	HA16	PL-4956-SB223	HA11
EHB002	HA16	PH-4958-EHB020	HA11
EHB003	HA16	PH-4960EHB021	HA11
EHB004	HA16	PKS-EB-4924-SBK802	HA9
EHB005	HA17	PLS-4931-SB202-RH	HA10
EHB006	HA17	PLS-4956-SB223	HA11
EHB010	HA17	PS-4919	HA9
EHB016-01 / 02	HA17	PS-4920	HA9
EHB016A-01 / 02	HA18	PS-4930	HA10
EHB017	HA18	PS-4958	HA11
EHB018	HA18	PS-EA-4926	HA10
EHB019	HA18	PS-EE-4922	HA9
EHB020	HA18	SD1-A	HA5
EHB021	HA18	SD1 / SD2 / SD3 / SD4	HA5
EHZ001	HA22	SE19	HA25
EHZ002	HA22	SEA19	HA25
EHZ003	HA22	SH19	HA25
EHZ004	HA22	SHA19	HA25
EHZ005	HA22	Fixing Method - Brass Series	HA15
EHZ006	HA22	Fixing Method - DH / SD Series	HA8
EHZ007	HA22	Fixing Method - EHB Series	HA21
P-165S	HA26	Fixing Method - EHZ Series	HA24
P-280S	HA26	Product Information - Brass Series	HA14
P-295S	HA26	Letters-Plate with Engraved Letters - Brass Series	HA15
P-305S	HA27	How to Order - Brass Series	HA15
PH-165	HA26	Finishes - Brass Series	HA15
PH-165S	HA26		
PH-280	HA26		
PH-280S	HA26		
PH-295	HA26		
PH-295S	HA26		
PH-305	HA27		
PH-305S	HA27		

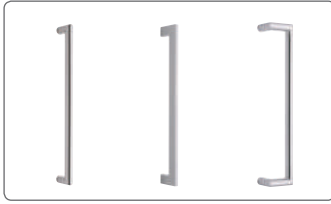

DH / SD Series - Door Handles

HA4-8



Brass Series - Push & Pull Plate with Handle

HA9-15



EHB Series - Door Handles

HA16-21



EHZ Series - Door Handles

HA22-24



SE / SH Series - Pull Handles

HA25



P / PH Series - Push Plate & Pull Handles with Plate

HA26-27

DH SERIES

Door Handles

Finishes : F16, F24, F25, F91, F93, F94, F96, F97

Materials : Stainless Steel

Rubber : One each Rubber Washer at each fixing point

Fixing Method : J, K, X Type

DH-20011



DH-20021



DH-20031



DH-20041



DH-20051



DH-20061



DH / SD SERIES

Door Handles

Finishes : F16, F24, F25, F91, F93, F94, F96, F97

Materials : Stainless Steel

Rubber : One each Rubber Washer at each fixing point

Fixing Method : J , K , X Typ

DH-20211



DH-20221



SD1-A



Only Y Type Fixing Method

SD1 / SD2 / SD3 / SD4



Only Y Type Fixing Method

DH / SD SERIES

Dimensions
in millimeters

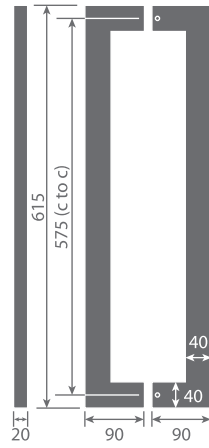

DH-20011

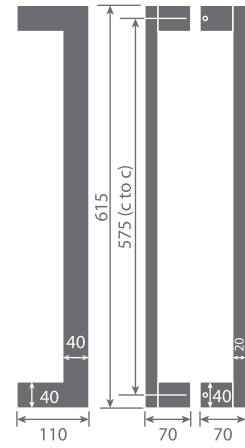

DH-20021

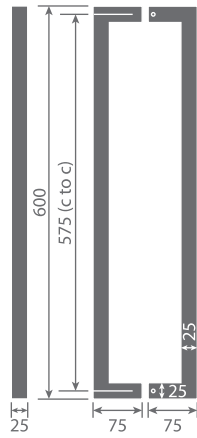

DH-20031

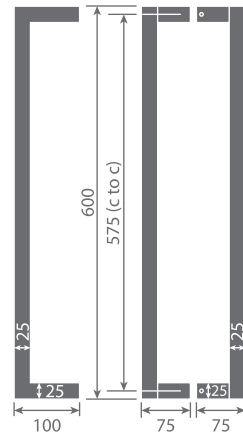

DH-20041

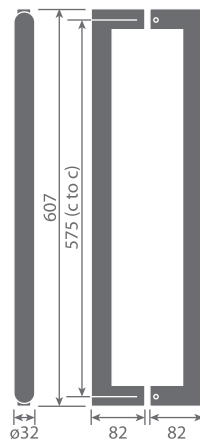

DH-20051

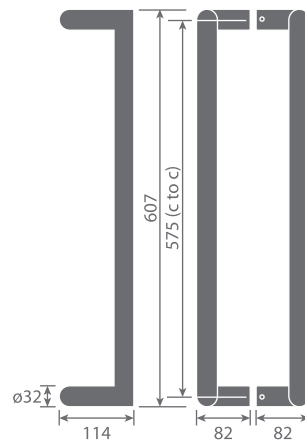

DH-20061

DH / SD SERIES

Dimensions
in millimeters

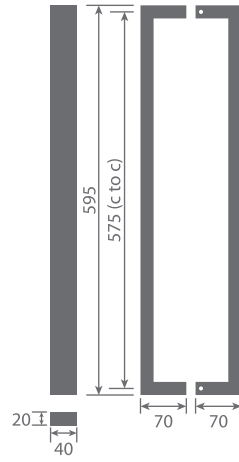

DH-20211

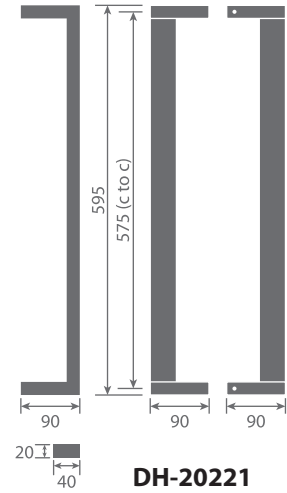

DH-20221

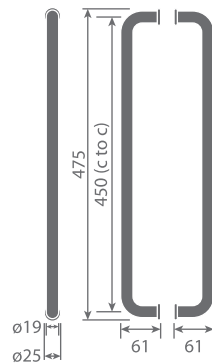

SD1-A

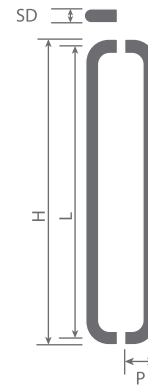

SD1 / SD2 / SD3 / SD4

SD (DIA.)		L (C to C)	H (HEIGHT)	P (PROJECTION)
SD1-X SD1-Y SD1-K SD1-J	19mm	152mm 230mm 300mm	171mm 249mm 319mm	57mm
SD2-X SD2-Y SD2-K SD2-J	25mm	300mm 457mm 600mm	325mm 482mm 625mm	63mm
SD3-X SD3-K SD3-J	32mm	300mm 457mm 600mm	332mm 489mm 632mm	70mm
SD4-X SD4-K SD4-J	38mm	300mm 457mm 600mm	338mm 495mm 638mm	76mm

Fixing Method

X TYPE = BACK TO BACK FIXING (DOUBLE HANDLES)

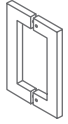

DH20011-X

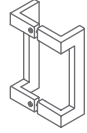

DH20021-X



DH20031-X

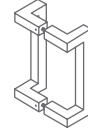

DH20041-X

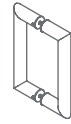

DH20051-X

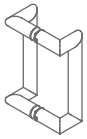

DH20061-X

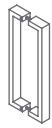

DH20211-X

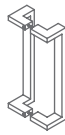

DH20221-X



SD1A



SD1~SD-4

Y TYPE = BACK FIXING WITH SCREW CAP



SD1-A

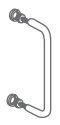

SD1



SD2



SD3



SD4

K TYPE = FACE FIXING



DH20011-K



DH20021-K



DH20031-K

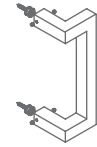

DH20041-K

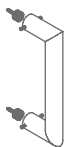

DH20051-K



DH20061-K



DH20211-K



DH20221-K

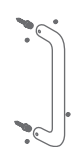

SD1~SD-4

J TYPE = BACK FIXING



DH20011-J



DH20021-J



DH20031-J



DH20041-J

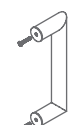

DH20051-J



DH20061-J



DH20211-J

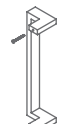

DH20221-J



SD1-A

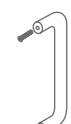

SD1~SD-4

BRASS SERIES

Push & Pull Plate
with Handle

This series is available in all finishes
(F16, F21, F22, F91, F93, F94, F96, F97).

Engraved letterings are available for the
electroplating finishes (F16, F21, F22).

PH-4919-EHB001

PS-4919



PH-4920-EHB001

PS-4920



PH-4922-EHB002

PS-EE-4922



PH-4924-EHB006

**PKS-EB-4924-
SBK802**



PHS-4926-EHB005

PS-EA-4926



PHS-4930-EHB004

PS-4930



PK-4931-SBK801

PLS-4931-SB202-RH



PL-4956-SB223 PLS-4956-SB223

NEW



PH-4958-EHB020 PS-4958

NEW



PH-4960-EHB021 PHS-4960-EHB021

NEW



BRASS SERIES

Dimensions
in millimeters

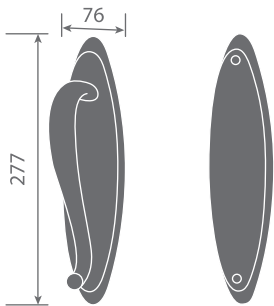

**PH-4919-
EHB001**

PS-4919

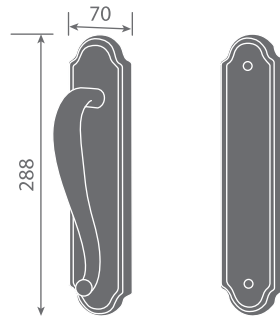

**PH-4920-
EHB001**

PS-4920

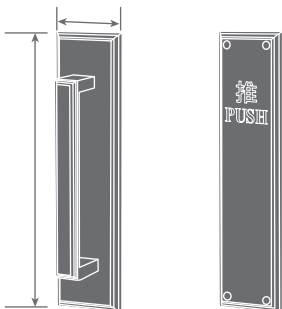

**PH-4922-
EHB002**

PS-EE-4922

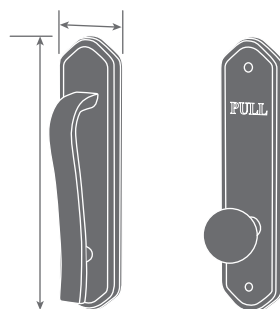

**PH-4924-
EHB006**

**PKS-EB-4924-
SBK802**



**PHS-4926-
EHB005**



PS-EA-4926

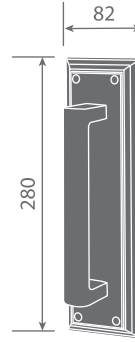

**PHS-4930-
EHB004**



PS-4930

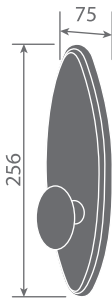

**PK-4931-
SBK801**

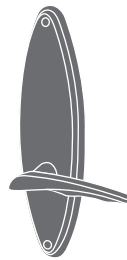

**PLS-4931-
SB202-RH**

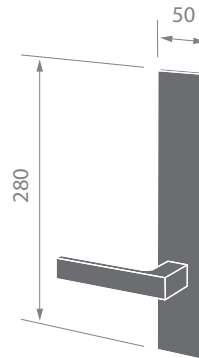

**PL-4956-
SB223**

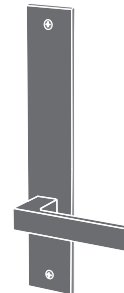

**PLS-4956-
SB223**

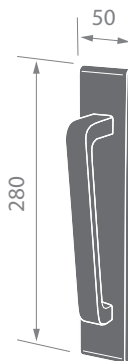

**PH-4960-
EHB021**



**PHS-4960-
EHB021**

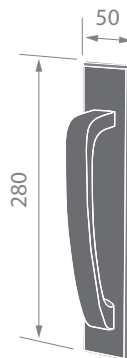





















**PH-4958-
EHB020**



PS-4958

Product Information

<p>P Plate (Back Fixing)</p>										
	P-4919	P-4920	P-4922	P-4924	P-4926	P-4930	P-4931	P-4956 <small>NEW</small>	P-4958 <small>NEW</small>	P-4960 <small>NEW</small>

<p>PS Plate (Surface Fixing)</p>										
	PS-4919	PS-4920	PS-4922	PS-4924	PS-4926	PS-4930	PS-4931	PS-4956 <small>NEW</small>	PS-4958 <small>NEW</small>	PS-4960 <small>NEW</small>

<p>PH Plate with Handle (Back Fixing)</p>	<p>PHS Plate with Handle (Surface Fixing)</p>										
		EHB001	EHB002	EHB003	EHB004	EHB005	EHB006	EHB010	EHB015	EHB017	EHB019 <small>NEW</small>

<p>PK Plate with Knob (Back Fixing)</p>	<p>PKS Plate with Knob (Surface Fixing)</p>						
		SBK-801	SBK-802	SBK-803	SBK-804	SBK-805	SBK-806

<p>PL Plate with Lever (Back Fixing)</p>	<p>PLS Plate with Lever (Surface Fixing)</p>					
		SB201	SB202	SB203	SB204	SB205
<p>LH</p>	<p>RH</p>					
		SB206	SB207	SB208	SB209	SB210
<p>LH</p>	<p>RH</p>					
		SB211	SB212	SB213	SB214	SB215
<p>LH</p>	<p>RH</p>					
		SB216	SB217	SB219	SB220	SB221
<p>LH</p>	<p>RH</p>					
		SB222	SB223	SB225	SB226	

EHB SERIES

Door Handles

Finishes: F16, F21, F22, F91, F93, F94, F96, F97

Material: Solid Brass

Rubber: One each Rubber Washer at each fixing point

Fixing Method: J, K, X, Y Type

EHB001

F97 Matt Brown Powder Coating



EHB002

F22 Stain Nickel



EHB003

F93 Matt White Powder Coating



EHB004

F91 Matt Black Powder Coating



EHB005

F91 Matt Black Powder Coating



EHB006

F21 Bright Chrome



Only Y, J Type Fixing Method

EHB010

F21 Bright Chrome



EHB016-01/02

F22 Stain Nickel

F21 Bright Chrome



EHB016A-01/02

F21 Bright Chrome F91 Matt Black Powder Coating



EHB017

F97 Matt Brown Powder Coating



EHB018

F21 Bright Chrome



EHB019

F97 Matt Brown Powder Coating

NEW



EHB020

F21 Bright Chrome

NEW



EHB021

F22 Stain Nickel

NEW



EHB SERIES

Dimensions
in millimeters

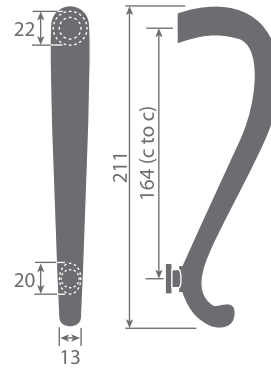

EHB001

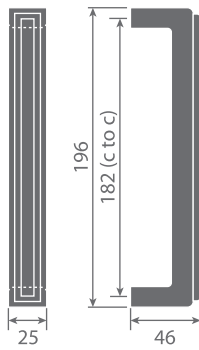

EHB002

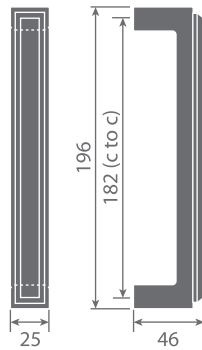

EHB003

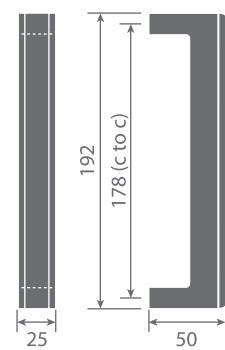

EHB004

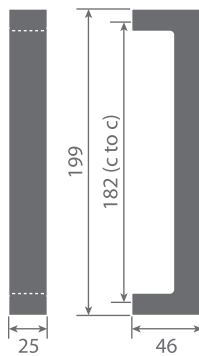

EHB005

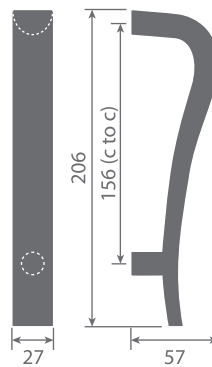

EHB006

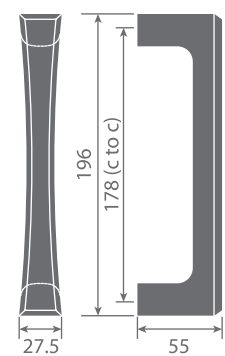

EHB010



EHB016-01/02
 01 = 226mm
 02 = 277mm

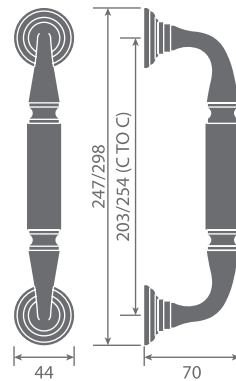

EHB016A-01/02
 01 = 247mm
 02 = 298mm

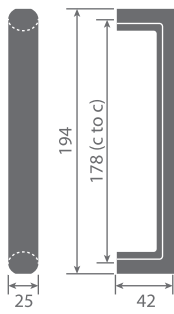

EHB017

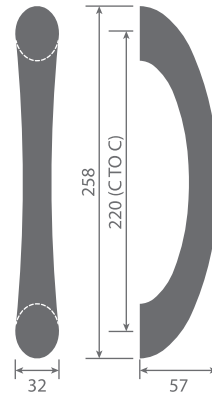

EHB018

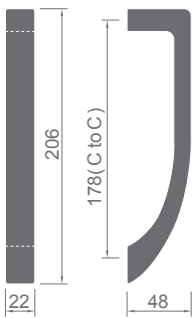

EHB019

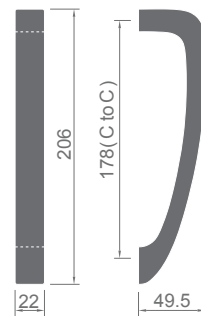

EHB020

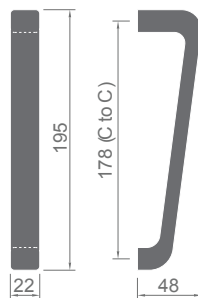

EHB021

Fixing Method

X TYPE = BACK TO BACK FIXING (DOUBLE HANDLES)

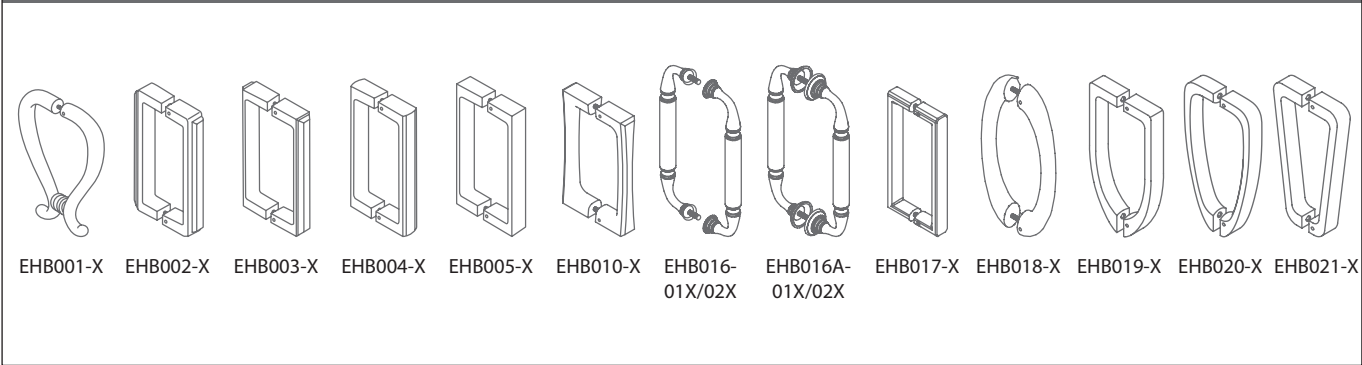

Y TYPE = BACK FIXING WITH SCREW CAP

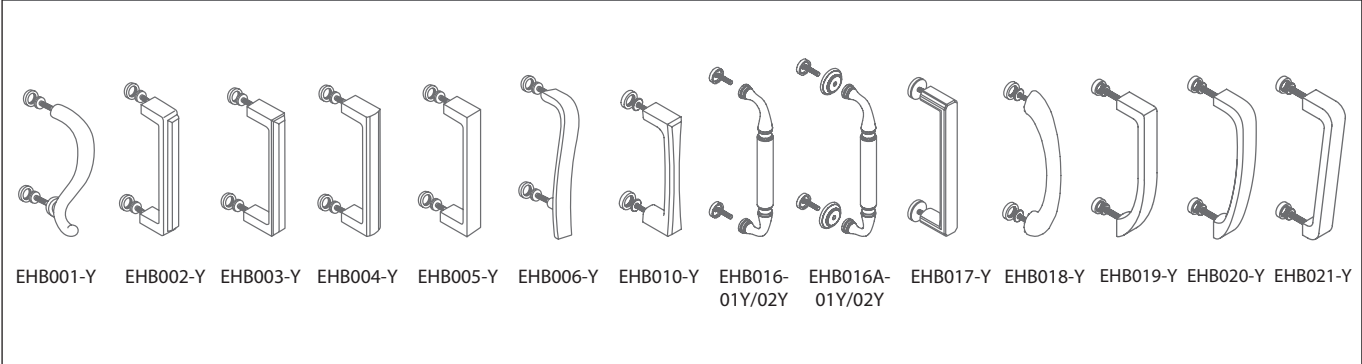

K TYPE = FACE FIXING

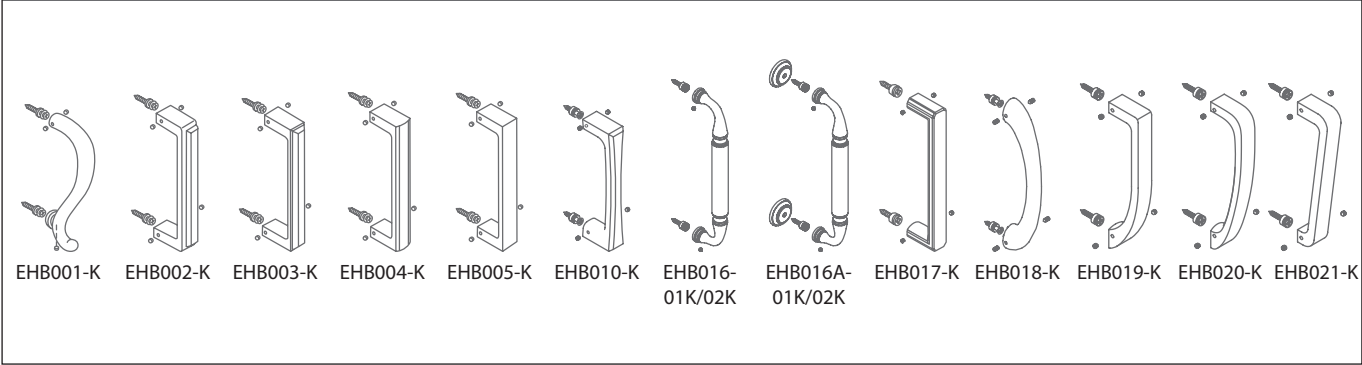

J TYPE = BACK FIXING

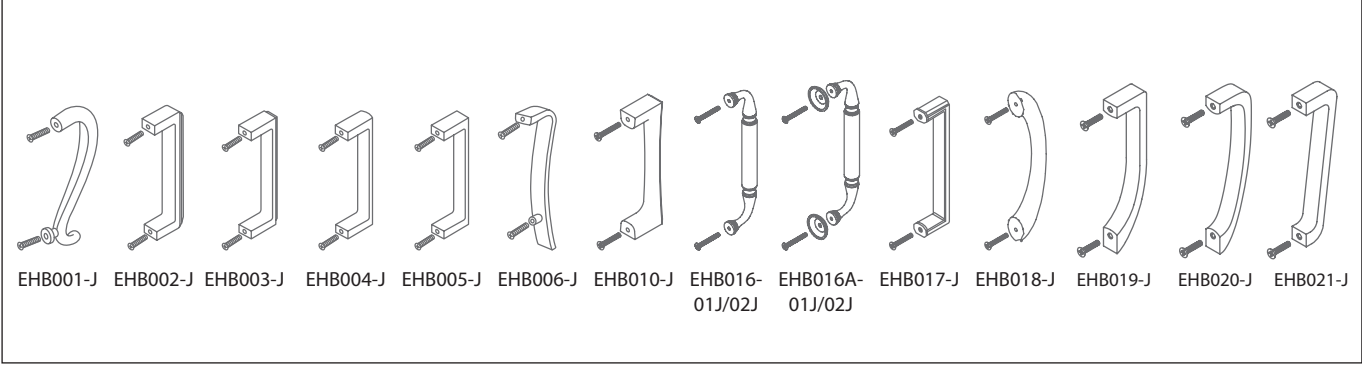

EHZ SERIES

Door Handles

Finishes: F21, F22, F91, F93, F94, F96, F97

Material: Zinc Alloy

Rubber: One each Rubber Washer at each fixing point

Fixing Method: J, K, X, Y Type

EHZ001

F97 Matt Brown Powder Coating



EHZ002

F21 Bright Chrome



EHZ003

F21 Bright Chrome



EHZ004

F21 Bright Chrome



EHZ005

F21 Bright Chrome



Only Y, J Type Fixing Method

EHZ006

F93 Matt White Powder Coating



EHZ007

F96 Matt D • Grey Powder Coating



EHZ SERIES

Dimensions
in millimeters

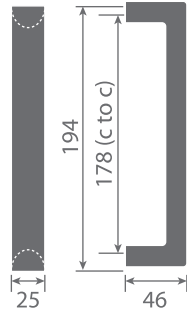

EHZ001

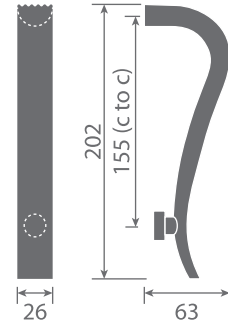

EHZ002

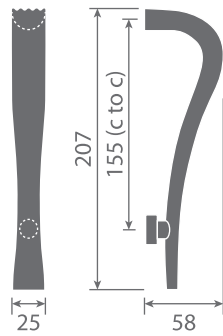

EHZ003

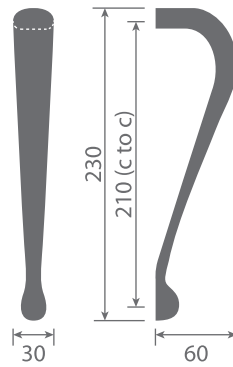

EHZ004

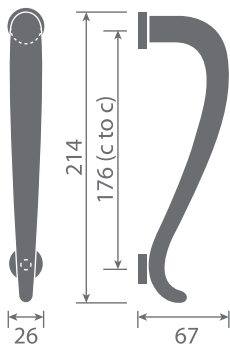

EHZ005

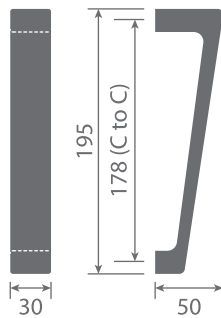

EHZ006

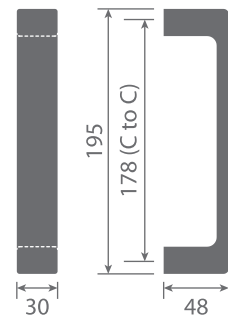

EHZ007

Fixing Method

X TYPE = BACK TO BACK FIXING (DOUBLE HANDLES)

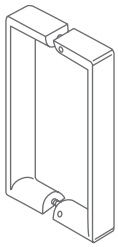

EHZ001-X

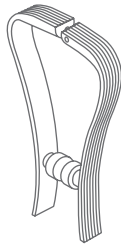

EHZ002-X

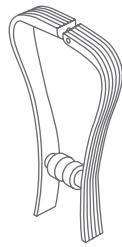

EHZ003-X



EHZ004-X

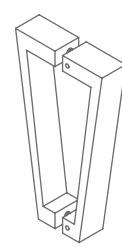

EHZ006-X

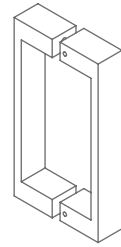

EHZ007-X

Y TYPE = BACK FIXING WITH SCREW CAP

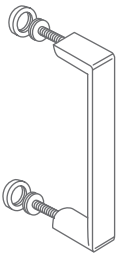

EHZ001-Y

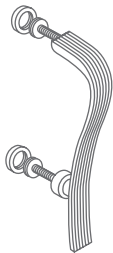

EHZ002-Y

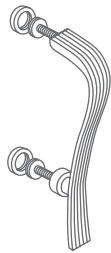

EHZ003-Y



EHZ004-Y

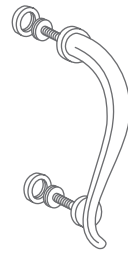

EHZ005-Y



EHZ006-Y

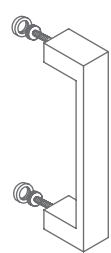

EHZ007-Y

K TYPE = FACE FIXING

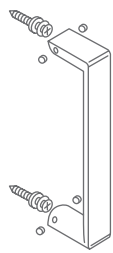

EHZ001-K

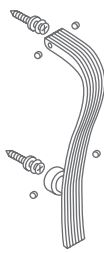

EHZ002-K

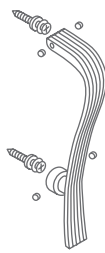

EHZ003-K



EHZ004-K

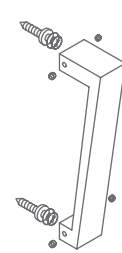

EHZ006-K

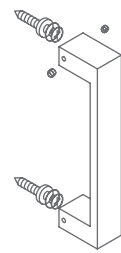

EHZ007-K

J TYPE = BACK FIXING

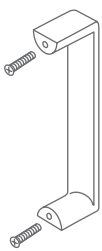

EHZ001-J

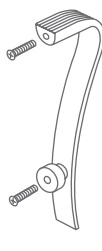

EHZ002-J



EHZ003-J



EHZ004-J



EHZ005-J

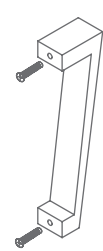

EHZ006-J

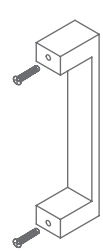

EHZ007-J

SE /SH SERIES

Pull Handles

Finishes : F16, F24, F25, F91, F93, F94, F96, F97
Materials : Stainless Steel

SE19



SEA19



SH19



SHA19



SE /SH SERIES

Dimensions
in millimeters

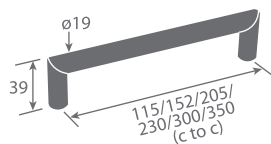

SE19

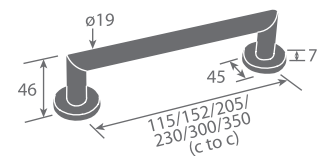

SEA19

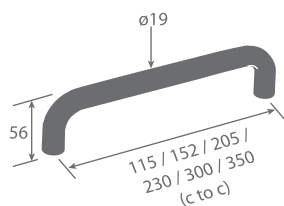

SH19

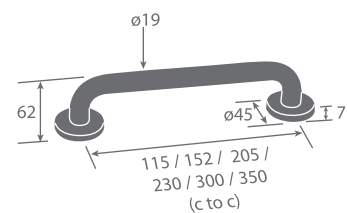

SHA19

P / PH SERIES

Push Plate &
Pull Handles with Plate

This series is available in all finishes
(F16, F24, F25, F91, F93, F94, F96, F97).

Laser engraved letters are available for
various finishes
(F16, F24, F25, F91, F93, F97).

Materials : Stainless Steel
Plate thickness : 1.5mm



(with Laser engraved letters)
(Letters are by customers request)

P-165S

Push plate



PH-165

Pull handle with plate



PH-165S

Pull handle with plate



P-280S

Push plate



PH-280

Pull handle with plate



PH-280S

Pull handle with plate



P-295S

Push plate



PH-295

Pull handle with plate



PH-295S

Pull handle with plate





P / PH SERIES
Dimensions
in millimeters

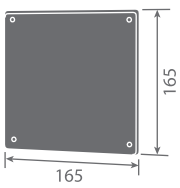
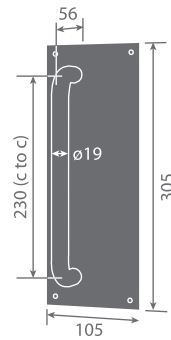

P-165S

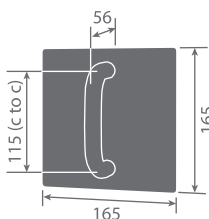

PH-165

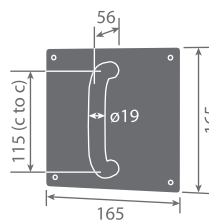

PH-165S

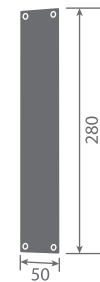

P-280S

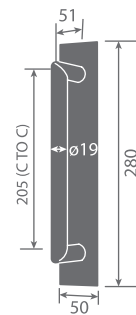

PH-280

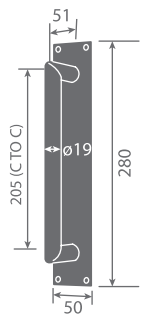

PH-280S

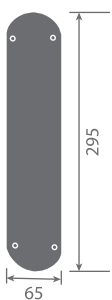

P-295S

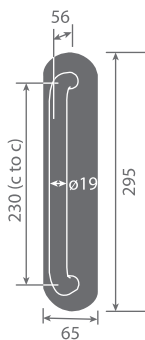

PH-295

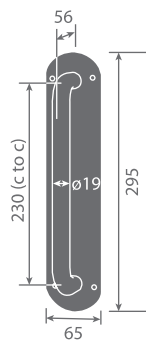

PH-295S



P-305S

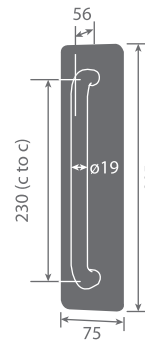

PH-305

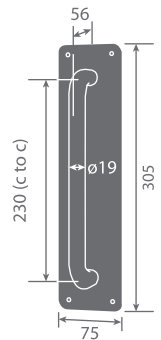

PH-305S



Name of quality & dependability

www.boncohardware.com

BONCO Ironmongery Ltd.
A Member of E. Bon Holdings (HKEx stock code 599)

16/F, First Commercial Building, 33 Leighton Rd., Causeway Bay, H.K.
Tel : (852) 2891 2188 Fax : (852) 2834 2652

